

TOTO

WASHLET

Instruction Manual

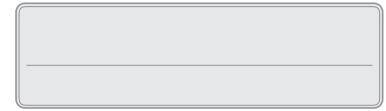

T1SW2491

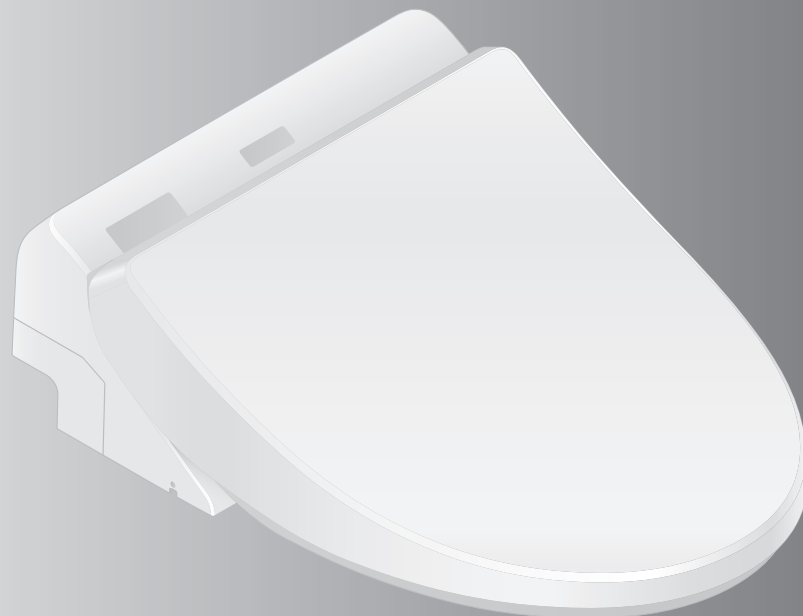

Thank you for your recent purchase of this product.

Please read the enclosed information to ensure the safe use of your product.

Be sure to read this Instruction Manual before using your product and keep it in a safe place for future reference.

Table of Contents

Introduction

Safety Precautions	4
Operational Precautions	9
Parts Names	12
Preparation	14
Using the Product for the First Time.....	14

Operation

Basic Operations	15
Mechanism of Auto Functions	15
Deodorizer	15
Pre-mist	15
Using the Remote Control	16
Stop	16
Rear washing	16
Front washing	16
Warm air drying	16
Water pressure adjustment	16
Wand position adjustment	16
Pulsating washing	16
Oscillating washing	16
Personal setting	16
Low battery warning mark	16
Power ON/OFF button	17
Wand cleaning	17
Warm water temperature	17
Toilet seat temperature	17
Drying air temperature	17
Auto energy saver	17
Timer energy saver	17
Setting confirmation	17

Temperature Adjustment	18
Warm water / Toilet seat / Drying	18
Changing Settings	20
Setting List	20
The energy saver features	22
How to Set.....	24
Auto energy saver.....	24
Timer energy saver	24
Pre-mist	25
Deodorizer	25
Beep sound	26
Pressure/Position setting	26
Personal setting	27
Registering Personal Settings	27

Maintenance

Maintenance	28
Before maintenance	28
Power Plug	28
Main Unit	29
Gap between the Main Unit and Bowl Unit.....	30
Gap between the Main Unit and the Toilet Lid...	31
Wand.....	32
Wand cleaning	32
Deodorizing Filter	32
Drain plug with water supply filter	33

Reference

What to Do?	34
If the water does not flow due to a water service interruption	34
If you cannot operate with the remote control	34
Replacing the batteries	34
Freeze Damage Prevention	35
Long Periods of Disuse.....	36
How to drain the water	36
Resupplying the Water.....	37
Troubleshooting	38
Please check first	38
Rear Washing, Front Washing and Wand	39
Warm air drying	40
Toilet Seat and Toilet Lid.....	40
Energy Saver.....	40
Deodorizer.....	41
Others	41
Specifications	42
Limited Warranty	43

The images shown are for illustration purposes only and may not be an exact representation of the product.

Safety Precautions

IMPORTANT SAFEGUARDS

READ ALL INSTRUCTIONS BEFORE USING

Symbols and Meanings

 **WARNING** May result in death or serious injury.

 **CAUTION** May result in injury or property damage.

WARNING

Never disassemble, repair or alter.

Doing so may cause fire, electrical shock, overheating, short circuit or breakdown.

Do not use the product if a malfunction occurs.

In case of breakdown or other problem, be sure to cut off power by means such as unplugging the power plug.

Close the water shutoff valve to stop water supply.

Possible malfunctions:

- Water is leaking from a pipe or the main unit.
- The product is cracked or broken.
- The product makes a strange noise or emits a strange odor.
- The product emits smoke.
- The product is abnormally hot.
- The toilet seat cushion is out of place.

Continued use after malfunction could cause a fire, electrical shock, heat, short circuit, injury or water damage.

Do not use other water than allowed by the laws and ordinances of the region of use. Only Use potable water.

Do not use seawater or recycled water.

Doing so may cause irritation to the skin and malfunction.

Keep cigarettes and other open flames away from the product.

Failure to do so may cause fire.

Refrain from sitting on the seat for long periods.

It may cause low-temperature burns.

To prevent the following persons from getting a moderate temperature burn during use, other person should turn off the toilet seat heater and set the dryer temperature to "Low".

- Young children, the aged and other users unable to set the temperature appropriately themselves.
- The ill, physically disabled and others who do not have freedom of movement.
- Those using any medicines that cause drowsiness (sleeping or cold medicine), those who have been drinking heavily, anyone severely fatigued and anyone else liable to fall asleep.

If the power cord is damaged, avoid danger by having the manufacturer's repair department or equivalent specialist replace it.

Turn the power OFF before maintenance or inspection.*1

Failure to do so may cause electrical shock or malfunction.

Always the power OFF before removing the main unit.*1

Failure to do so may cause a fire or electrical shock.

*1 How to turn off the product (→Page 14)

WARNING

When leaking battery fluid adheres to your body or clothes, wash it away with clean water.

The fluid may damage your eyes or skin.

Do not stick a finger or anything else into the warm air outlet.

Do not place anything on the warm air outlet or drape clothes over it.

Doing so may cause burns, electrical shock or malfunction.

Do not install the product on moving vehicles such as wheeled vehicles or boats.

Doing so may cause fire, electric shock, short circuit or malfunction.

The toilet seat, toilet lid, main unit, or other parts may come loose and fall off, resulting in injury.

Do not use any power supply other than the one specified.

AC 120 V, 60 Hz

Doing so may cause fire or excessive heat.

This is an electrical product. Do not install it anywhere water is likely to get on the product or anywhere with humidity high enough that water is likely to form on the surface of this product. When using the product in a bathroom, install a fan or ventilation port and ensure good air flow through the bathroom.

Failure to do so may cause fire or electrical shock.

Always connect the product to the cold water supply.

Connecting to hot water supply may result in burns and equipment damage.

Preliminary studies in females suggest that overuse of continuous spraying can increase the possibility of vaginal mucosa drying and potential reduction in desirable microbial organisms.

Although these studies have not been validated, please consult your healthcare provider for concerns regarding whether these circumstances may apply to you.

More importantly, if you are an individual suffering from any immune deficiency as a result of disease, chemotherapy, or other medical condition compromising the immune system you should consult your healthcare provider before use of this product.

Do not touch the connection of power cord with wet hands.

Doing so may cause electrical shock.

Do not allow any water or cleaning solution on the gaps between the main unit, main unit and bowl unit, or power supply connections.

Doing so may cause fire, electrical shock, heat or short circuit.

Doing so may cause the product to crack resulting in injury or water damage.

Do not touch the power source connection during thunderstorms.

Doing so may cause electrical shock.

Do not allow the water supply hose to touch the power source connection.

Doing so may cause condensation resulting in a fire, electrical shock, heat or a short.

Do not do anything that may damage the power cord or power source connection.

Do not strike, yank, twist, excessively bend, damage, alter, or heat the power cords.

Also, do not place anything heavy on, bind or pinch the power cords.

Using a damaged power cord may result in a fire, electrical shock, heat or short.

Safety Precautions

WARNING

Confirm that a properly grounded outlet has been installed.

Failure to install a grounded outlet could cause electrical shock in the event of a malfunction.

*If there is no ground installed, ask the contractor who did the installation to install the ground.

Periodically remove dust and dirt from the power plug and make sure it is securely plugged into the wall outlet.

Failure to do so may cause fire, heat or short circuit. Pull the power plug out from the outlet and wipe clean with a dry cloth.

Do not use a loose or faulty electrical outlet.

Doing so may cause fire or short circuit.

Do no use any outlet beyond its specified rating.

Plugging too many plugs into the same outlet, for example using outlet splitters, can cause fire due to heat.

Insert the power plug securely into the outlet.

Failure to do so may cause fire, heat or short circuit.

To unplug, hold the power plug, not the power cord.

Do not unplug by pulling the power cord.

Pulling on the power cord may cause damage and result in fire or heat.

CAUTION

Do not use the product if the main unit is unstable.

Doing so may cause the main unit to come loose and fall, resulting in injury.

If the product is damaged, do not touch the damaged section.

Doing so may cause electrical shock or injury. Replace it immediately.

Do not apply strong force, mechanical shock, step on or stand on the toilet seat, toilet lid or main unit. Also do not place any heavy object on the toilet seat, toilet lid or main unit.

Doing so may cause cracking or cause the main unit to come loose and fall, resulting in injury. Doing so may damage the product and cause injury or water damage.

Do not lift up this product by the toilet seat or lid.

Do not raise the toilet seat or lid while objects are resting on top of the unit.

Doing so may cause the main unit to come loose and fall, resulting in injury.

When maintaining the plastic parts (main unit etc.) or the water supply hose, use a pH neutral kitchen detergent diluted with water. Do not use any of the following.

Toilet cleaner, household cleaner, benzene, paint thinner, powdered cleanser or nylon scrubbing brush.

These items may damage or crack the plastic and cause injury or malfunction.

These items could damage the water supply hose and cause a water leak.

CAUTION

To prevent a sudden water leak, do not remove the drain plug with water supply filter when the shutoff valve is open.

Doing so will cause water to spurt out.
(→Refer to Page 33 for instructions on cleaning the drain plug with water supply filter.)

Do not fold or crush the water supply hose; do not damage by cutting with a sharp object.

Doing so may cause water leaks.

Do not install the base plate, which is not attached.

Doing so may cause damage.

If a water leak should occur, always close the shutoff valve.

When the ambient temperature is likely to drop to 32 °F (0 °C) or lower, prevent damage to the pipes and hoses due to freezing.

Frozen water pipes could cause the main unit and the pipes to break, resulting in a water leak.
Regulate the room temperature to prevent the pipes and hoses from freezing during cold months.
Drain the water.

When not using the product for a long time, close the shutoff valve, drain the water from the main unit and water supply hose, and then turn the power OFF.*1

When using the product again, allow the product to refill with water first. Otherwise, the water in the tank might become contaminated and cause skin inflammation or other problems. (→Refer to Page 37 for instructions on replenishing the water.)
Leaving the power on may cause fire or heat.

When installing the drain plug with water supply filter, make sure that it is securely tightened in its proper position.

Failure to securely tighten it may cause a water leak.

If the bowl is clogged, turn the power OFF*1 and remove the clog.

Use commercially available tools that are made for unclogging the bowl unit to remove the clogging.

Push the main unit securely on to the base plate.

After pushing the main unit until a click sound is heard, pull it slightly toward you to make sure that the product does not detach.
Doing so may cause the main unit to come loose and fall, resulting in injury.

Make sure of the plus and minus signs on the batteries before inserting them.

Remove depleted batteries immediately.

When replacing the batteries:

- Replace both batteries with new ones.
- Use the same brand for both new batteries (any brand available).

Failure to do so may cause the batteries to leak fluid, generate heat, rupture, or ignite.

When the product is supposed not to be used for long time, remove the batteries from the remote control.

Failure to do so may cause the batteries to leak fluid.

*1 How to turn off the product (→Page 14)

Safety Precautions

DANGER

To reduce the risk of electrocution:

1. Do not use while bathing.
2. Do not place or store the product where it can fall or be pulled into a tub or sink.
3. Do not place in or drop into water or other liquid.
4. Do not reach for the product when it has fallen into water. Unplug it immediately.

WARNING

To reduce the risk of burns, electrocution, fire or injury to persons:

1. Close supervision is necessary when this product is used by, on, or near children or invalids.
2. Use this product only for its intended use as described in this manual. Do not use attachments not recommended by the manufacturer.
3. Never operate this product if it has a damaged cord or plug, is not working properly, has been dropped or damaged, or has been dropped in water. Return the product to a service center for examination and repair.
4. Keep the cord away from heated surfaces.
5. Never block the air openings on the product or place it on a soft surface, such as a bed or couch, where the air openings may be blocked. Keep the air openings free of lint, hair, and other similar items.
6. Never use while sleepy or drowsy.
7. Never drop or insert any object into any opening or hose.
8. Do not use outdoors. Do not operate where aerosol (spray) products are being used or where oxygen is being administered.
9. Connect this product to a properly grounded outlet only.
See "Grounding Instructions" in below.
10. The tank should be filled with water only.

- Servicing should be performed by an authorized service representative.
- This product is for household use.

Grounding Instructions

This product should be grounded. In the event of an electrical short circuit, grounding reduces the risk of electric shock by providing an escape wire for the electrical current.

This product is equipped with a cord having a grounding wire with a grounding plug.

The plug must be plugged into an outlet that is properly installed and grounded.

 **DANGER** - Improper use of the grounding plug can result in a risk of electric shock.

If repair or replacement of the cord or plug is necessary, do not connect the grounding wire to either flat-head terminal.

Check with a qualified electrician or serviceman if the grounding wire instructions are not completely understood, or if in doubt as to whether the product is properly grounded.

SAVE THESE INSTRUCTIONS

Operational Precautions

For prevention of malfunctions

Do not block the remote control transmitter or receiver.
May cause main unit to malfunction.

About the seat switch

When you sit on the toilet seat, the seat switch turns ON, enabling you to use various features.
(A click sound is heard when the seat switch is ACTIVATED.)

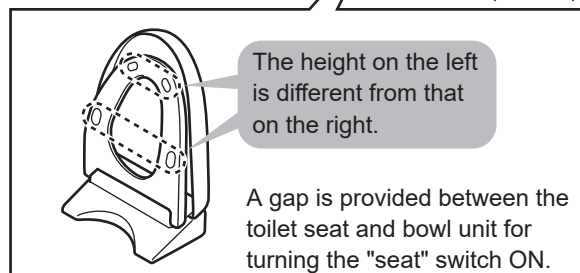
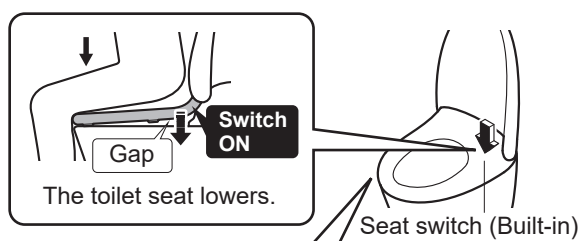

Sit back on the toilet seat.

The seat switch will not turn on unless you sit on the seat properly.

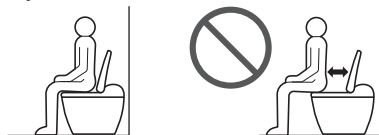

Note: When a child uses the product, the seat switch may not be ACTIVATED by their light body weight. Since the toilet seat is designed to move up and down, a clearance is provided between the toilet seat cushion and the bowl unit.

For prevention of damage

Wipe plastic areas such as the main unit and remote control with a soft cloth tightly wrung out with water.

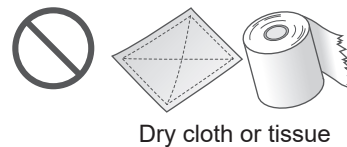

Do not lean against the toilet lid.



Operational Precautions

For prevention of malfunctions and failures

Turn the power OFF if there is a risk for lightning strike.*1

A toilet seat cover or a toilet lid cover cannot be used.

Otherwise, the seat switch may not detect properly. Additionally, the toilet seat and lid may not open or close properly.

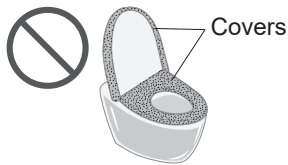

Do not urinate on the main unit, toilet seat or wand.

Doing so may cause a failure or discoloration.

Do not apply strong forces to the control panel of the remote control.

When using a toilet cleaner to clean the toilet, rinse it off within 3 minutes and leave the toilet seat and toilet lid open.

If vapor from a toilet cleaner enters the main unit, it may cause a malfunction.

► Wipe off any cleaner that remains on the bowl unit.

Do not use the product with the toilet lid removed.

Do not expose to direct sunlight.

Doing so may cause changes in color, irregular heated seat temperature or remote control malfunction.

It may also cause product malfunction due to the change in temperature.

Use radios, etc. away from the product.

The product could cause interference with the radio signal.

If you use a booster seat for infants or a soft highchair, remove it after use.

Keeping it installed may prevent some of the functions from being used.

Do not apply force to the remote control.

This cause malfunction.

► To prevent the remote control from being dropped, set it in the hanger when you are not using it.

Be careful not to expose it to water.

Do not place anything on the toilet seat and lid, and do not press them with hands.

Doing so may activate the seat switch, causing the floor to get wet if buttons on the remote control are touched and warm water comes out from the wand.

*1 How to turn off the product (→Page 14)

Parts Names

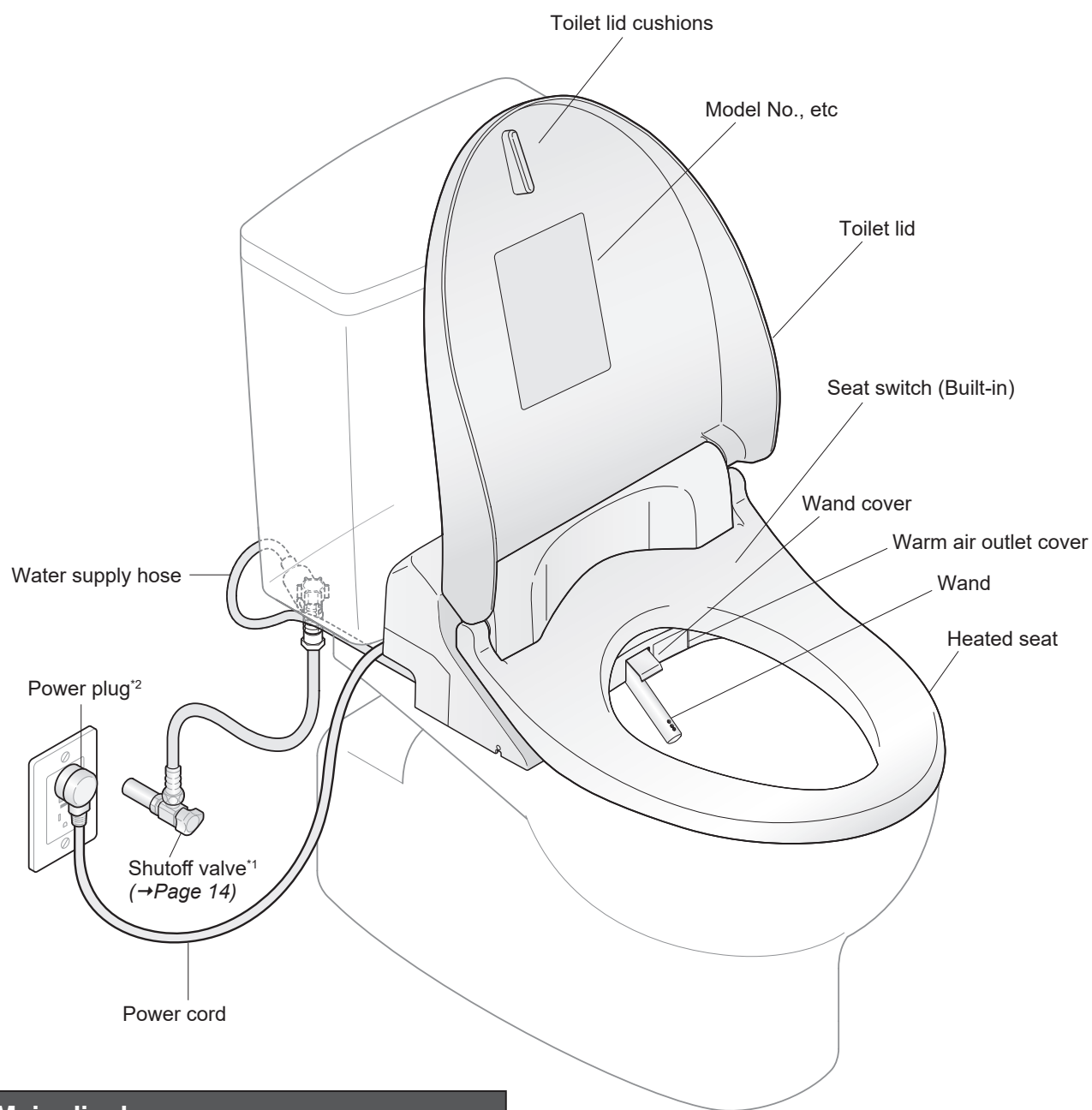

A: Main display

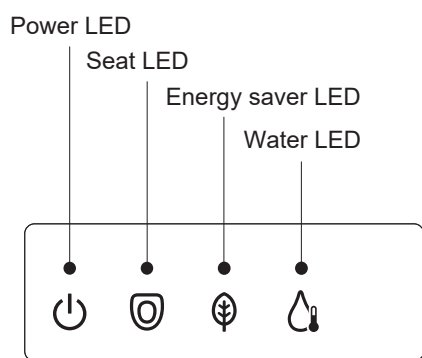

<All the LEDs illuminate in the figure>

*1 The shape and location vary depending on the type of bowl unit and tank.

*2 The shape of the power plug may vary.

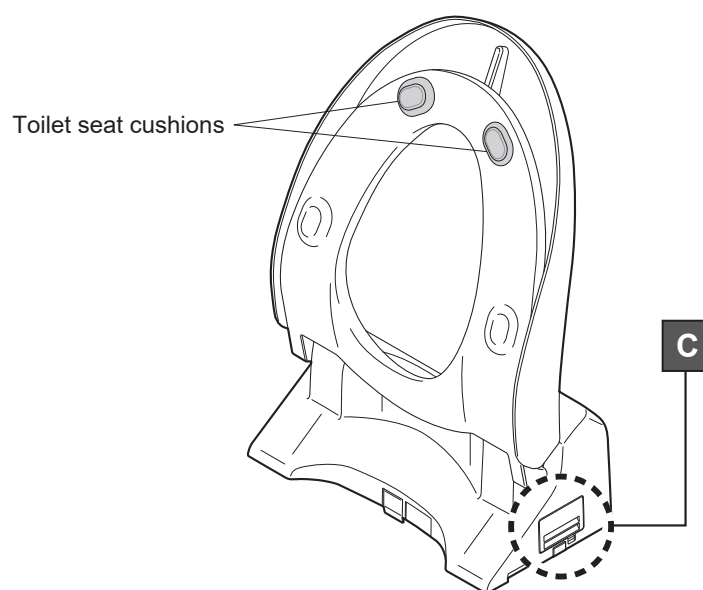
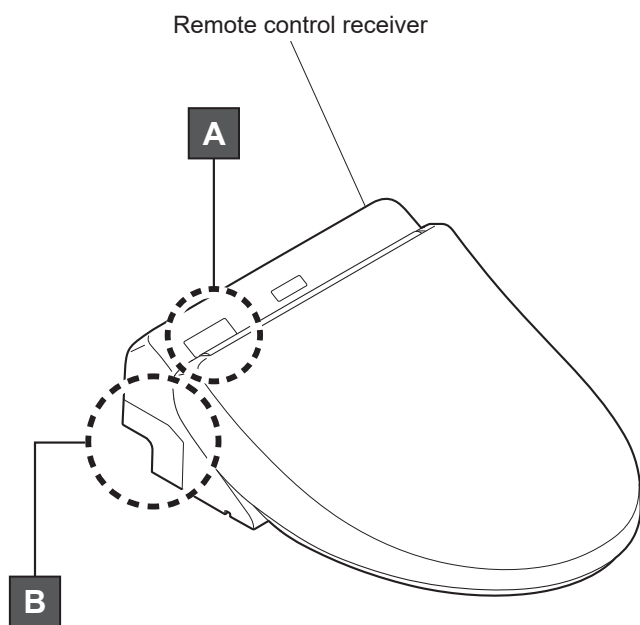

B: Left side of the main unit

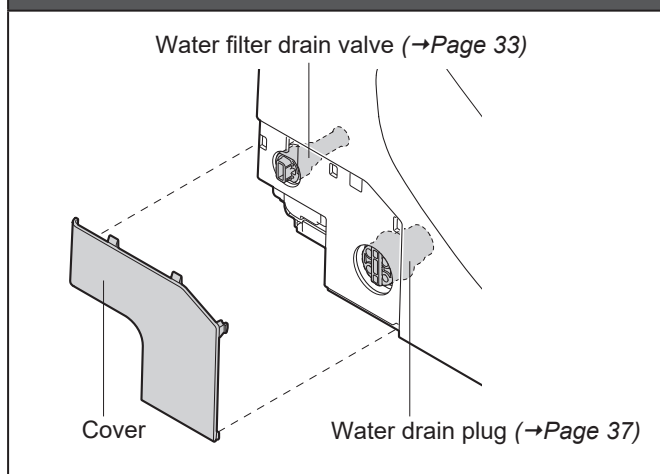

C: Right side of the main unit

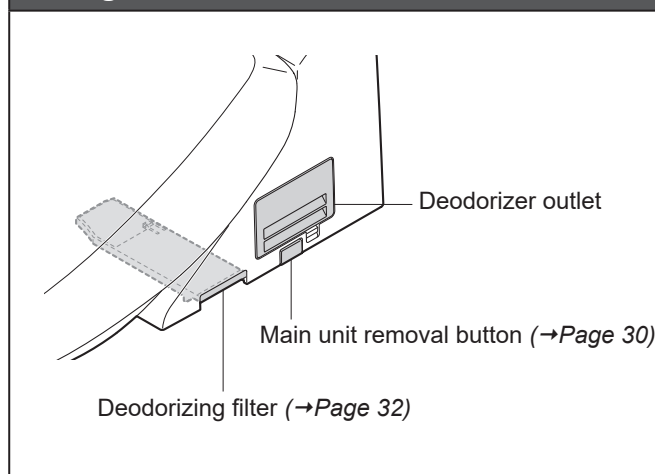

Preparation

Using the Product for the First Time

1. Insert the battery

1.1 Remove the remote control from the hanger.

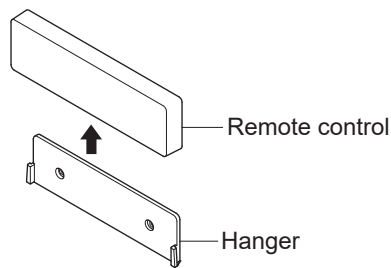

1.2 Open the battery cover and insert two AAA batteries.

After inserting batteries, close the battery cover.

Remote control back side

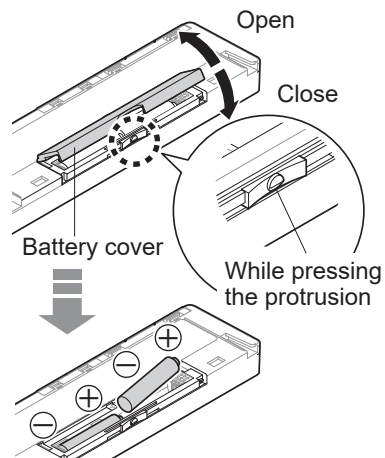

- ▶ When batteries are properly loaded, all the LEDs on the remote control light up for about 2 sec.

1.3 Mount the remote control in the hanger.

About the batterie

Use dry cell, alkaline batteries.

Be sure to follow "Safety Precautions" to prevent the batteries from rupturing or leaking fluid. (→Pages 5, 7)

2. Turn on the power

2.1 Insert the power plug.

- ▶ The wand extends and then retracts.

2.2 Check the "Power" LED illuminates.

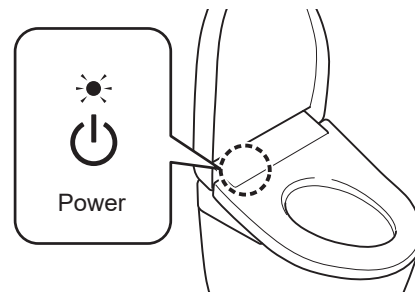

If the light is off

Switch "Power" to "ON" using the remote control.

- ▶ Press "Power ON/OFF" button about 3 seconds or longer.

To turn the power "OFF"

Unplug the power plug.

- ▶ The "Power" LED is unilluminated.

3. Open the shutoff valve

3.1 Fully open the shutoff valve.

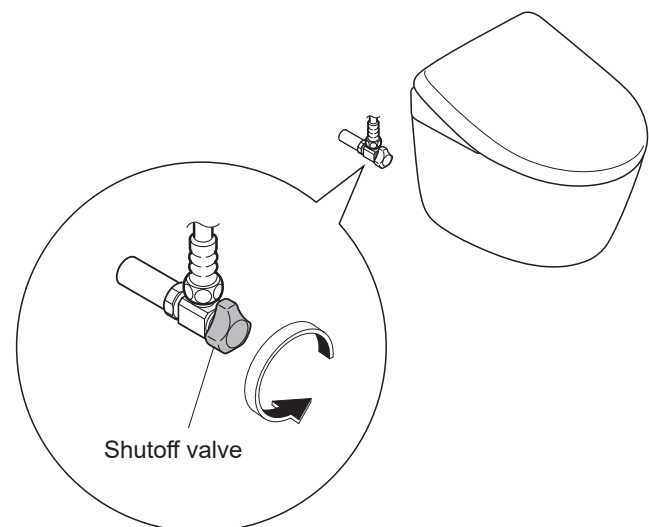

Basic Operations

Mechanism of Auto Functions

Operation under the default settings is described in "Mechanism of Auto Functions".

These mechanisms be changed.
(→Pages 20–27 "Changing Settings")

1. As you approach



2. As you sit



Pre-mist
Deodorizer

Pre-mist

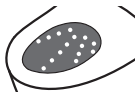

A mist is automatically sprayed inside the bowl unit to make it more difficult for dirt to adhere.

Deodorizer

Starts the deodorizer



Removing odors inside the bowl unit.

Note: Deodorizing filter needs regular maintenance.

(→Page 32)

3. As you stand up*1



Deodorizer stops after about 60 seconds.

*1 To keep clean the wand every time it is used, water remaining in the wand is drained after you stand up from the toilet seat.

Basic Operations

Using the Remote Control

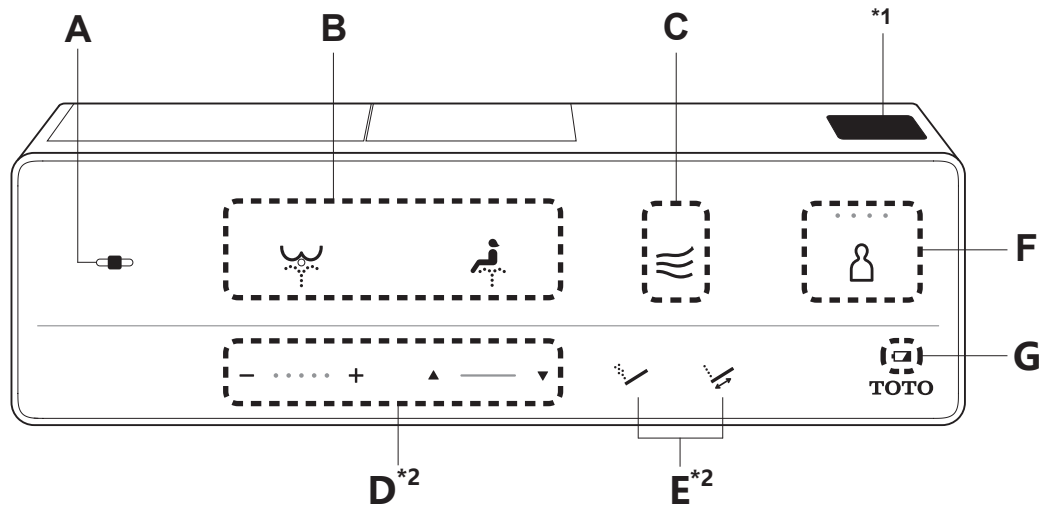

Operate the controls on the remote control; a beep sounds when the main unit receives the signal.

- A** **Stop**
Stops the B or C operation.
- B** **Rear washing**
Washes your rear.

Front washing
Serves as a bidet for ladies.
- C** **Warm air drying**
Dries your rear.
- D** **Water pressure adjustment**
You can adjust the water pressure to one of five levels. [-] Softer, [+] Stronger
After you press the "Water pressure adjustment" button, the set position will light for 10 seconds.

Wand position adjustment
You can adjust the washing position to 5 different points between the front and the rear, using the [▲] and [▼] buttons.

Once use of the remote control is finished, the settings will return to the initial setting (3rd position) after a while, not exceeding a maximum of 5 minutes.

If you do not want to return to 3rd position (→Page 26)

Note: *Sitting back on the toilet seat makes it easier to adjust the wand position and to reduce splashing.*

- E** **Pulsating washing**
Washes with the water pressure pulsating between soft and strong.

Oscillating washing
The wand moves back and forth to washes your rear thoroughly.

Note: *Sitting back on the toilet seat makes it easier to adjust the wand position and to reduce splashing.*
- F** **Personal setting**
Up to four people can register their preferred "Water pressure", "Wand position" and "Warm water temperature" settings. (→Page 27)

To use

 - 1) Press the button to turn on the LED for the location of your setting.
 - ○ ○ ○ Register1
 - ● ○ ○ Register2
 - ● ● ○ Register3
 - ● ● ● Register4
 - 2) Press the wash button you want to use ("Rear washing", etc.)

- G** **Low battery warning mark**
(→Page 34)

*1 Remote control transmitter

*2 While using B, these buttons and their functions can be operated.

Remote control back side

How to remove the remote control (→Page 14)

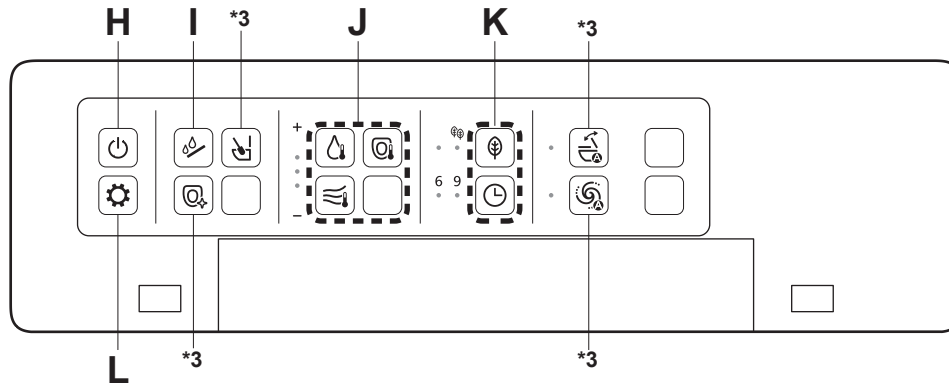

Operate the controls on the remote control; a beep sounds when the main unit receives the signal.

This section is an overview of the settings that can be configured with the remote control. See the corresponding pages for the detailed descriptions.

H



"Power ON/OFF" button
Press and hold for 3 seconds or longer to turn washlet operation on/off.

K



Auto energy saver



Timer energy saver

Saving energy (→Page 24)

I



Wand cleaning
(→Page 32)

Note: It cannot be used when the wand is out or when you are sitting on the toilet seat.

L



Setting confirmation
The current setting can be discerned from the LEDs.

J



Warm water temperature



Toilet seat temperature



Drying air temperature

Adjust temperatures (→Pages 18, 19)

*3 The button is not used with this product, so pressing it does not perform operations.

Temperature Adjustment

Warm Water, Toilet Seat, Drying

Three different temperature levels from high to low and "OFF" can be set.

Remote control back side

How to remove the remote control (→Page 14)

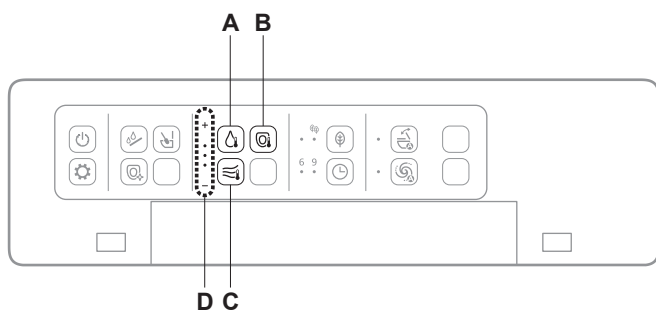

- A Warm water temperature button**
(When you want to adjust the warm water temperature)
- B Toilet seat temperature button**
(When you want to adjust the toilet seat temperature)
- C Drying air temperature button**
(When you want to adjust the drying air temperature)
- D Displaying the temperature level of the pressed button**

Adjusting the temperature

- 1.** Remove the remote control from the hanger.
(→Page 14)
- 2.** Choose and press the button of the temperature that you want to set from the ("Toilet seat temperature" button), ("Warm water temperature" button) and (Drying air temperature button).
 - ▶ The current temperature level appears.

- 3.** Press the button selected in step 2 repeatedly until a desired temperature level illuminates.

▶ The setting changes each time the button is pressed once

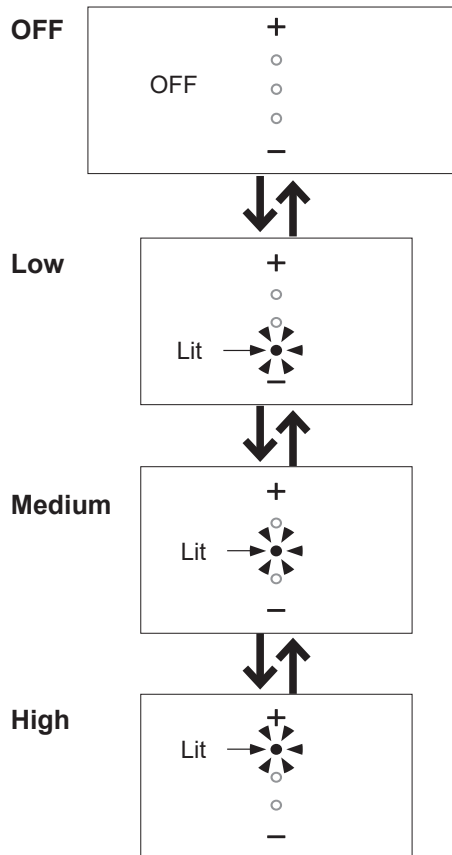

Settings complete

▶ When seat temperature and water temperature are set, the SEAT LED and WATER LED illuminate.

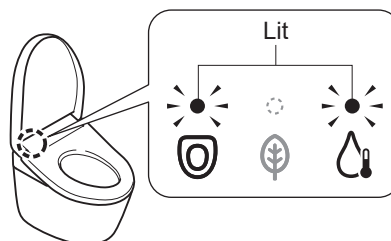



Note: The "Drying" cannot be turned "OFF".
If the button is not pressed for about 10 seconds, the "Temperature adjustment" LED will go off, but the setting will be retained.
If the "Temperature adjustment" LED goes out before the setting is completed, start all over again at step 2.

- 4.** Mount the remote control in the hanger.
(→Page 14)

If adjusting the temperature does not warm up the toilet seat.

▶ Is the energy saver set to "ON"? (→Page 24)

To turn the warm water temperature*1 and toilet seat temperature "OFF"

1. Remove the remote control from the hanger.
(→Page 14)
2. Select a temperature button you want to turn "OFF" from  ("Toilet seat temperature" button),  ("Warm water temperature" button) and press it.
 - ▶ The current temperature level appears.

3. Press the button selected in step 2 repeatedly until the temperature level is set to "OFF".

▶ The setting changes each time the button is pressed once

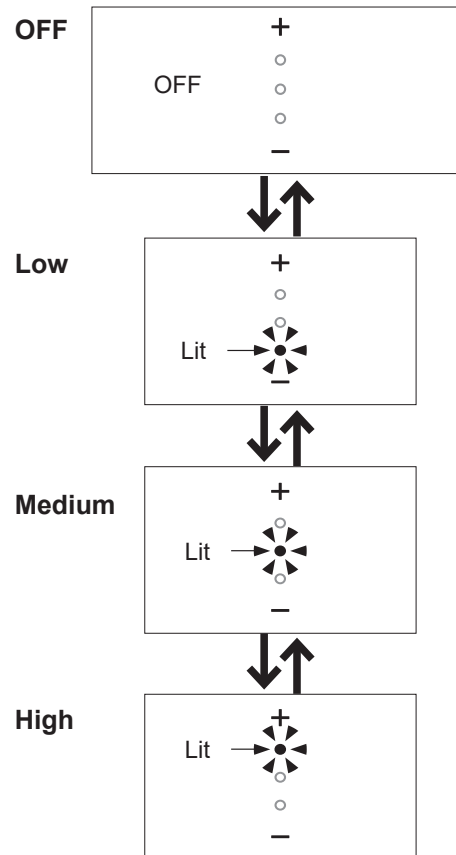

Settings complete

▶ When seat temperature and water temperature are OFF, the SEAT LED and WATER LED are unilluminated.

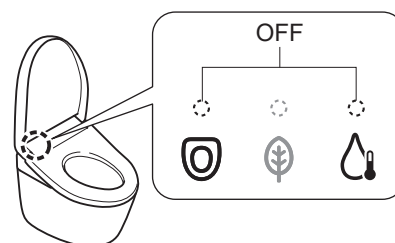

Note: The "Drying" cannot be turned "OFF".

4. Mount the remote control in the hanger.
(→Page 14)

*1 To prevent condensation, the water temperature does not drop below 68 °F (20 °C) even when set to "OFF".

Changing Settings

Setting List

Setting Types	Available Settings Bold: Initial settings
Auto energy saver (→Page 24)	ON/ OFF
Timer energy saver (→Page 24)	6H/9H/ OFF
Pre-mist (→Page 25)	ON /OFF
Deodorizer (→Page 25)	ON /OFF
Beep sound (→Page 26)	ON /OFF*1
Pressure/position setting (→Page 26)	ON/ OFF
Personal setting (→Page 27)	ON /OFF
Registering Personal Settings (→Page 27)	Register 1/Register 2/Register 3/Register 4



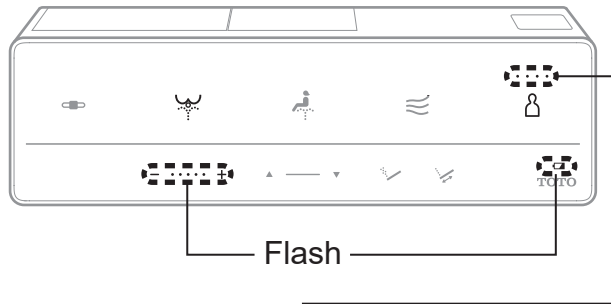

*1 The beep sounds when settings are being changed, even if the beep noise is turned off. (except for "Pressure/position setting" or "Personal setting")

Setting with buttons on the front of the remote control.

Press the button indicated in step 1 for approximately 10 seconds or longer to enter setting mode. (→Pages 25-27)



Check

- 
 Press "Stop" button about 10 seconds or longer.
 
-  and  Press "Stop" button and "Water pressure adjustment +" button at the same time about 10 seconds or longer.
 

Note: During setting, if the next button is not pressed within about 60 seconds, the light will stop flashing. If you fail to complete the setting, redo from the step 1.

Setting with buttons on the back of the remote control.

Remote control back side

How to remove the remote control (→Page 14)

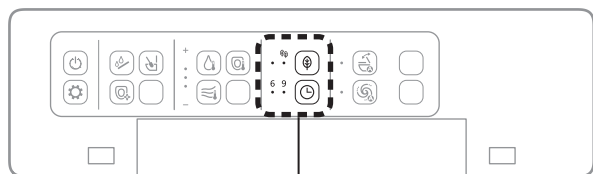

Use the LED to check settings.

▶ **Setting buttons (→Pages 24–27)**

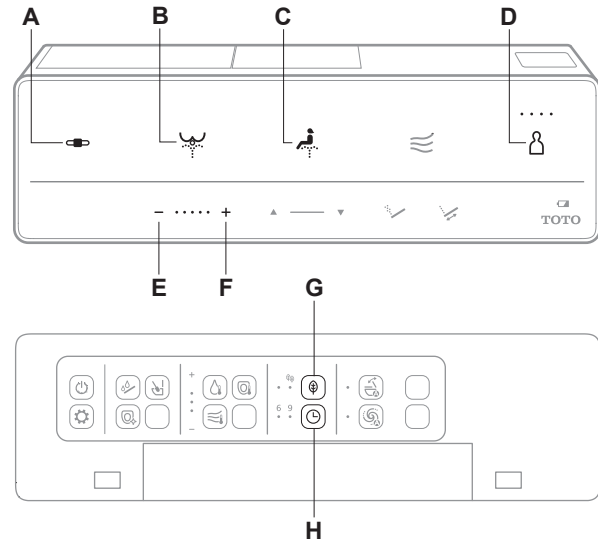

- A** Stop button
- B** Rear washing button
- C** Front washing button
- D** Personal setting button
- E** Water pressure adjustment - button
- F** Water pressure adjustment + button
- G** Auto energy saver button
- H** Timer energy saver button

Changing Settings

The energy saver features

"Auto energy saver" and "Timer energy saver" can be selected. To save energy, lower (or turn "OFF") the seat or warm water temperature.

Note: Even if the energy saver is being activated (with the toilet seat heater set to "Low" or "OFF," or with the warm water heater set to "OFF"), the toilet seat will be temporarily heated when you sit on it.

(To reach the setting temperature, the toilet seat takes about 15 minutes and the warm water about 10 minutes, respectively.)

The LED indication on the main display returns to the state for when the energy saver is on.

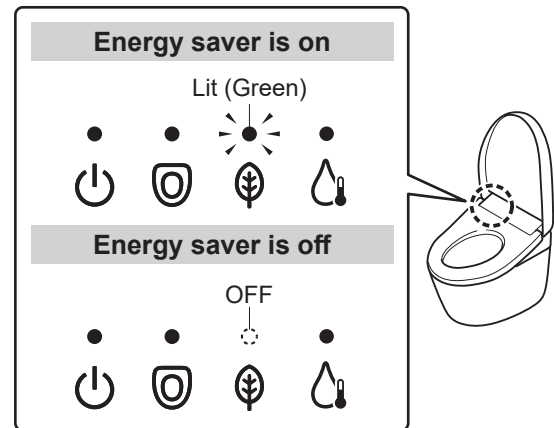

Auto energy saver

You want the product to save energy automatically

The product detects time periods with infrequent use and lowers the toilet seat temperature automatically.

It takes about 10 days for the product to determine the periods when it is used relatively less frequently.

When energy saver is in operation

Main display

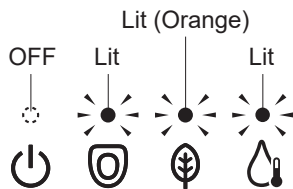

Toilet seat heater



Warm water heater



Example

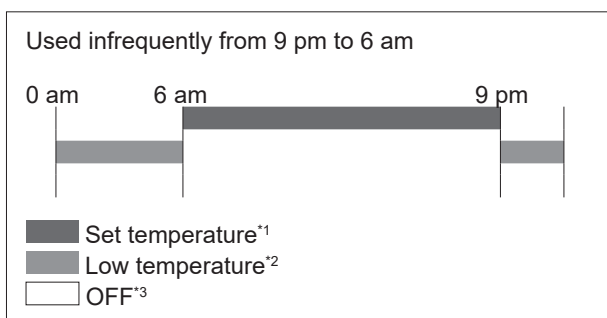

Timer energy saver

You want to save energy only for a preset duration of time. (6 hours, 9 hours)

Once the time is set, the toilet seat heater and warm water heater will be turned off automatically every day at that same time.

When energy saver is in operation

Main display

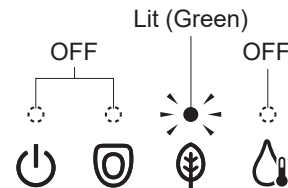

Toilet seat heater



Warm water heater



Example

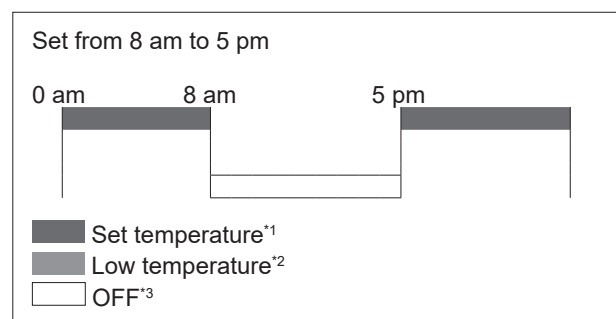

*1 The toilet seat temperature settings on pages 18, 19.

*2 The time period when the toilet seat heater is set to a "Low". The warm water heater is "Set temperature".

*3 The time period when the toilet seat heater and warm water heater are "OFF".

Timer energy saver and Auto energy saver

You want to save the maximum amount of energy possible?

When both "Timer energy saver" and "Auto energy saver" are set, "Auto energy saver" operates when "Timer energy saver" is not operating.

When energy saver is in operation

Main display

During "Auto energy saver":

- ▶ Same LED indication as "Auto energy saver".
(→Page 22)

During "Timer energy saver":

- ▶ Same LED indication as "Timer energy saver".
(→Page 22)

Toilet seat heater

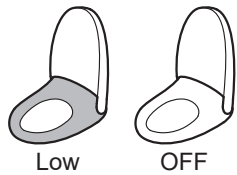

Warm water heater

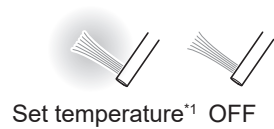

Example

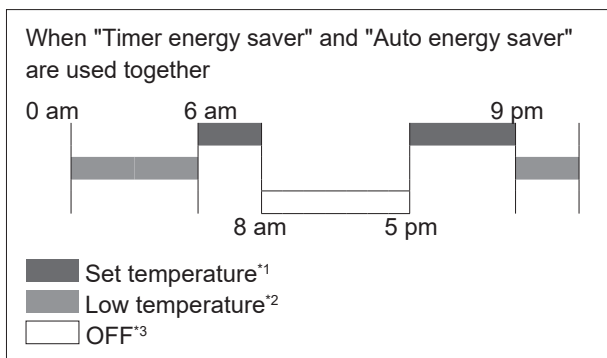

Changing Settings

How to Set

Auto energy saver



Press "Auto energy saver" button.

- ▶ The setting changes each time the button is pressed once.

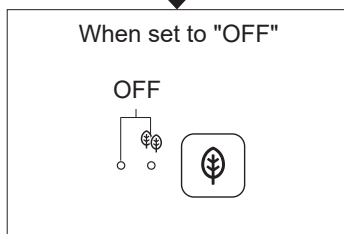
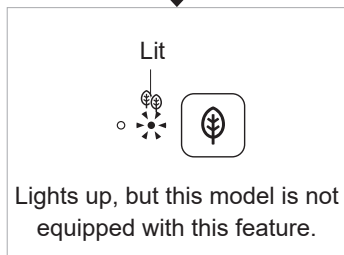
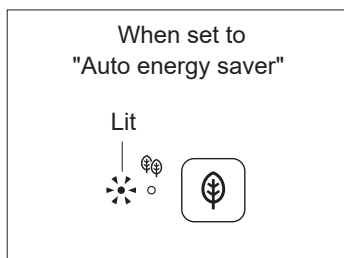

Settings complete

Timer energy saver

Set the "Timer energy saver" at the time you want to start it.

Example: To save energy from 1 am to 7 am (for 6 hours)



When the time of the day reaches 1:00 am at night, press "Timer energy saver" button.

Press the "Timer energy saver" button repeatedly until the "6" LED illuminates.

- ▶ The setting changes each time the button is pressed once.

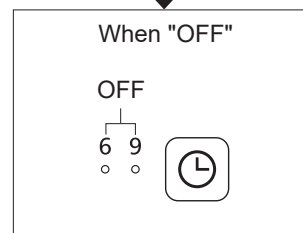
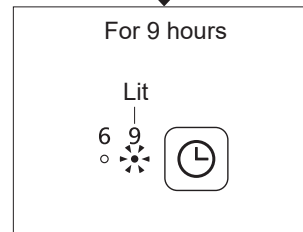
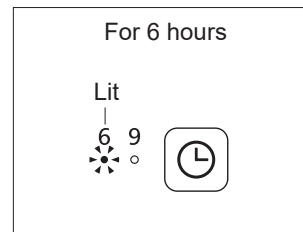

Settings complete

Pre-mist

Set whether or not to spray mist in the bowl unit automatically

1. ■

Press "Stop" button until all LEDs on the remote control are lit or flashing. (about 10 seconds)

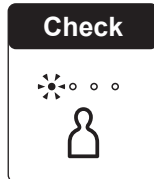

2. +

Press "Water pressure adjustment +" button.

3. 

Press "Front washing" button.

4. Choose and press the button of the item that you want to set.

Set whether or not to spray mist in the bowl unit automatically.

When set to "Spray" Press "Water pressure adjustment +" button. + Short beep	When set to "do not spray" Press "Water pressure adjustment -" button. - Long beep
--	--

Settings complete

Deodorizer

Set whether or not to deodorize automatically after sitting on the toilet seat

1. ■

Press "Stop" button until all LEDs on the remote control are lit or flashing. (about 10 seconds)

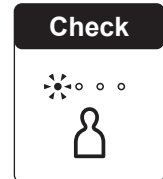

2. -

Press "Water pressure adjustment -" button.

3. 

Press "Front washing" button.

4. Choose and press the button of the item that you want to set.

Set whether or not to deodorize automatically after sitting on the toilet seat.

When set to "ON" Press "Water pressure adjustment +" button. + Short beep	When set to "OFF" Press "Water pressure adjustment -" button. - Long beep
---	---

Settings complete

Changing Settings

Beep sound

Set whether or not to make a beep sound

1.  and **+**

Press and hold both the "Stop" button and "Water pressure adjustment +" button until the remote control LEDs are lit or flashing. (about 10 seconds)

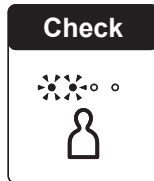

2. **-**

Press "Water pressure adjustment -" button.

3. 

Press "Rear washing" button.

4. Choose and press the button of the item that you want to set.

Set whether or not to make a beep sound.

<p>When set to "ON"</p> <p>Press "Water pressure adjustment +" button.</p> <p>+</p> <p>Short beep</p>	<p>When set to "OFF"</p> <p>Press "Water pressure adjustment -" button.</p> <p>-</p> <p>Long beep</p>
--	--

Settings complete

Pressure / position setting

Set whether or not to keep your favorite pressure and position settings

1.  and **+**

Press and hold both the "Stop" button and "Water pressure adjustment +" button until the remote control LEDs are lit or flashing. (about 10 seconds)

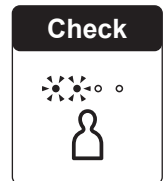

2. 

Press "Rear washing" button.

3. **+**

Press "Water pressure adjustment +" button.

4. **-**

Press "Water pressure adjustment -" button.
▶ The current setting is displayed.

5. **-**

Press "Water pressure adjustment -" button.
▶ The setting changes each time the button is pressed once.

Pressure/Position setting

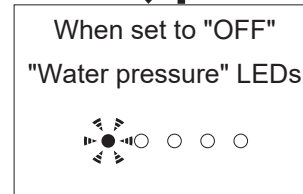
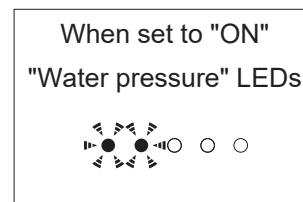

6. 

Press "Stop" button.

Settings complete

Personal setting

Set whether or not to use the personal setting

1. ■ and +

Press and hold both the "Stop" button and "Water pressure adjustment +" button until the remote control LEDs are lit or flashing. (about 10 seconds)

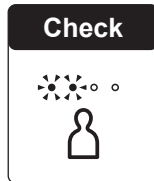

2. -

Press "Water pressure adjustment -" button.

3. +

Press "Water pressure adjustment +" button.

4.

Press "Front washing" button.
▶ The current setting is displayed.

5. -

Press "Water pressure adjustment -" button
▶ The setting changes each time the button is pressed once.

Personal setting

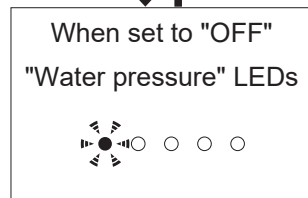
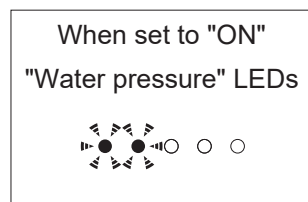

6. ■

Press "Stop" button.
Settings complete

Registering Personal Settings*1

Register your preferred wand position, etc.

1.

Press "Personal setting" button.

Select the location to be set

▶ The setting changes each time the button is pressed once.

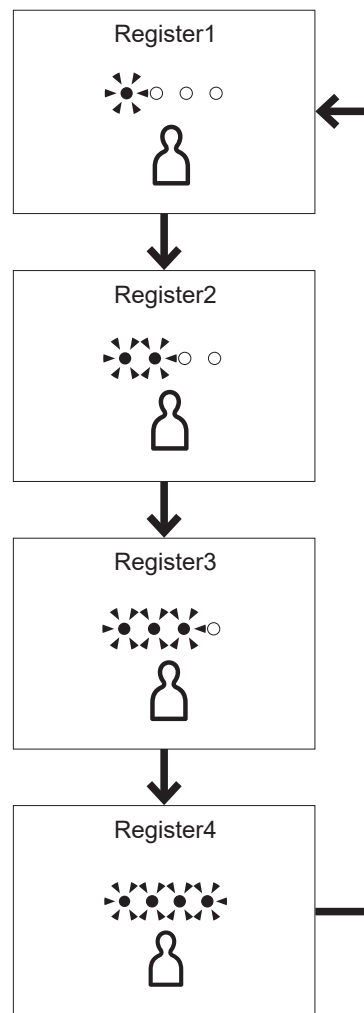

2. Set your preferences for "Wand position", "Water pressure" and "Warm water temperature" during "Rear washing", etc.

3.

Press "Personal setting" button about 5 seconds or longer. (Short beep)

Settings complete

*1 Cannot be performed when "Personal setting" is set to "OFF".

Maintenance

Before maintenance

⚠ WARNING

Always turn off the power before maintenance or inspection.

Failure to do so may cause electric shock or malfunction, resulting in a breakdown.

For safety, turn the power OFF before maintenance.*1

When the power is turned OFF, the Power LED is unilluminated.



To turn the power "OFF"

Unplug the power plug.

To turn the power "ON"

Insert the power plug.

▶ The "Power" LED illuminates.

Power Plug

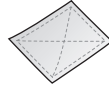

• Dry cloth



• Wet cloth

Approximately once a month

1. Unplug the power plug and wipe it with a dry cloth.



2. Insert the power plug.

▶ The "Power" LED illuminates.

⚠ WARNING

Periodically remove dust from the blades and other parts of the power plug.

Unplug the power plug and wipe it with a dry cloth.

Fully insert the power plug.

When unplug the power plug, hold the main body of the power plug.

Pulling the power cord may damage the power plug or power cord.



*1 Except when using "Wand cleaning".

Main Unit



- Soft cloth soaked in water

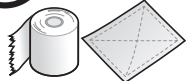

- Toilet paper
 - Dry cloth
 - Nylon scrubbing brush
- May cause damage.

Approximately daily

1. Turn the power "OFF". (→Page 28)

2. Wipe with a soft cloth that has been soaked in water and wrung out thoroughly.

For heavy dirt

Wipe with a soft cloth soaked in diluted, pH neutral kitchen detergent, and then wipe with a soft cloth soaked in water.

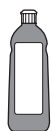

- pH neutral kitchen detergent



- Paint thinner
- Benzene
- Powdered cleanser

3. Turn the power "ON". (→Page 28)

- ▶ The "Power" LED illuminates.

Attention

This product is an electric appliance. Be careful not to let water seep inside or leave detergent in the gap between the main unit and bowl unit.

Do not put any cleaning solution directly onto the warm air outlet or cover around the wand, etc.

May damage plastic parts or cause a malfunction.

When using a toilet cleaner to clean the toilet, rinse it off within 3 minutes and leave the toilet seat and toilet lid open.

Wipe off any cleaner that remains on the bowl unit. If vapor from a toilet cleaner enters the main unit, it may cause a malfunction.

Do not press or pull the warm air outlet or cover around the wand with excessive force.

Doing so may cause damage or failure.

Wipe the back surface of the toilet seat and the toilet seat cushions with a soft cloth tightly wrung out with water.

Otherwise adhesion of dirt may result in discoloration.

Maintenance

Gap between the Main Unit and Bowl Unit

You can remove the main unit to clean the top of the bowl unit and the bottom of the main unit.



- Soft cloth soaked in water



- Toilet paper
 - Dry cloth
 - Nylon scrubbing brush
- May cause damage.

Approximately once a month

1. Turn the power "OFF". (→Page 28)



CAUTION

If the power is not turned off, the unit may malfunction, causing a failure or electric shock.

2. Remove the main unit.

Pull the main unit toward you while pressing the "Main unit removal button".

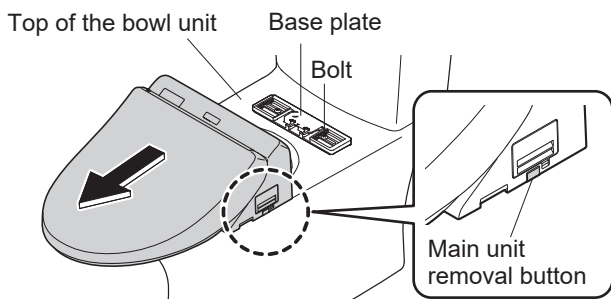

Attention

Do not pull the unit with undue force.
Because the water supply hose and power cord are attached.
Do not excessively bend the water supply hose.

3. Clean the top of the bowl unit and the bottom of the main unit.

Wipe with a soft cloth soaked in a diluted, pH neutral kitchen detergent. Then, dry the surface with a soft cloth soaked in water so that no detergent remains.

4. Mount the main unit.

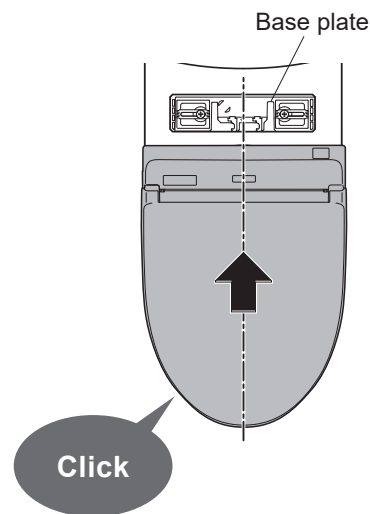

Align the main unit with the center of the base plate and press it firmly onto the base plate until a click sound is heard.

Attention

Be careful not to pinch the power cord.
Do not excessively bend the water supply hose.



CAUTION

Push the main unit firmly on to the base plate until a click sound is heard.
Doing so may cause the main unit to come loose and fall, resulting in injury.

- ▶ After mounting, check that the main unit does not detach even when pulled.

5. Turn the power "ON". (→Page 28)

- ▶ The "Power" LED illuminates.

Gap between the Main Unit and the Toilet Lid

The toilet lid can be removed for thorough cleaning.

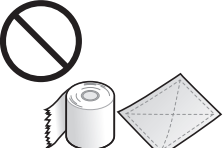
-  • Soft cloth soaked in water
-  • Toilet paper
• Dry cloth
• Nylon scrubbing brush
May cause damage.

Approximately once a month

1. Turn the power "OFF". (→Page 28)

2. Remove the toilet lid.

Slightly tilt the toilet lid to the front.

- A** Pull left side outward.
- B** Disconnect the hinge from the recess and pull up.
- C** Disconnect the right side.

Hold with both hands

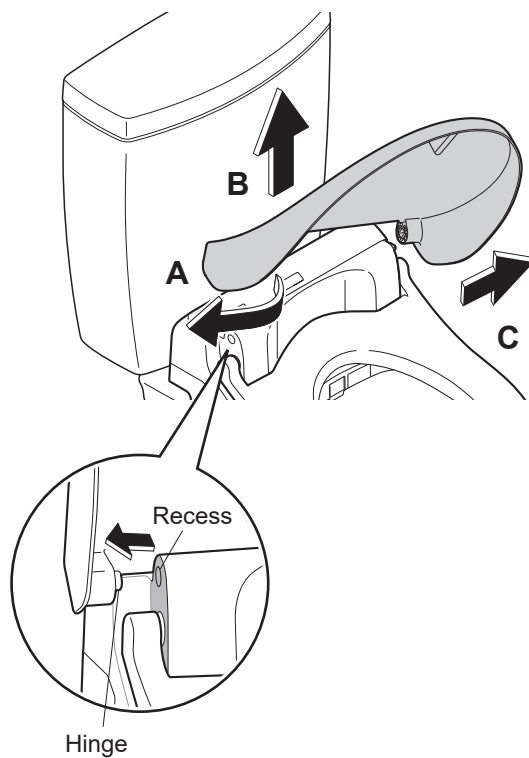

3. Wipe with a soft cloth that has been soaked in water and wrung-out thoroughly.

4. Reinstall the toilet lid.

- D** Align the right side pin and hinge parts. Slightly tilt the toilet lid to the front.
- E** While pulling left side outward.
- F** Mount by joining the hinge with the recess.

Attention

Be careful not to pinch your fingers.

Hold with both hands

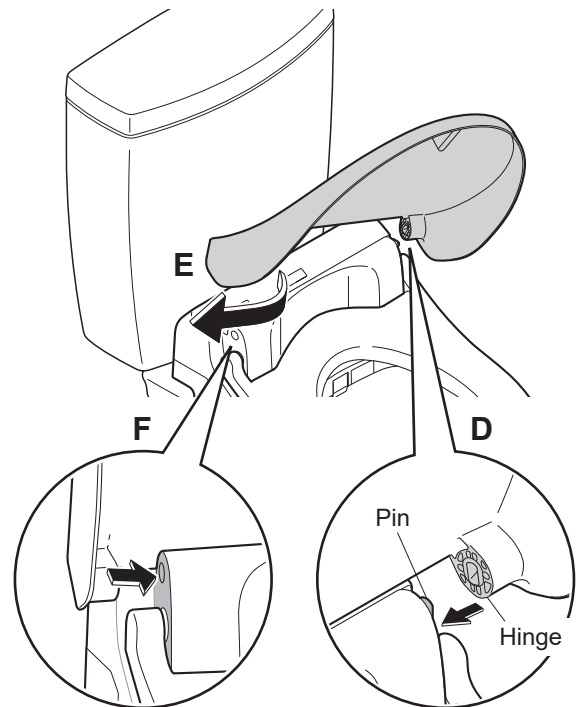

5. Turn the power "ON". (→Page 28)

► The "Power" LED illuminates.

6. Open and close the toilet lid to check the reinstallation.

Maintenance

Wand



- Soft cloth

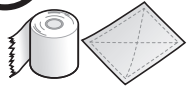

- Toilet paper
 - Dry cloth
 - Nylon scrubbing brush
- May cause damage.

Approximately once a month If you notice dirt (Wand cleaning)

1. Extend the wand.

Remote control back side

How to remove the remote control (→Page 14)



Press "Wand cleaning" button.

- ▶ The wand extends and water sprays out for cleaning.
- ▶ The wand automatically retracts after about 5 minutes.

2. Wipe with a soft, wet cloth.

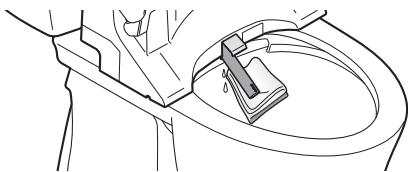

Attention

Do not pull, push or press the wand with excessive force.
May cause damage or malfunction.

3. ■

Press "Stop" button.

- ▶ The wand retracts.

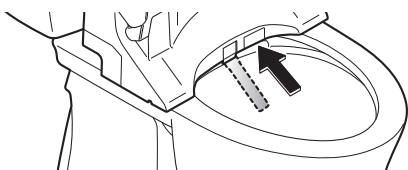

Deodorizing Filter

Approximately once a month

1. Turn the power "OFF". (→Page 28)

2. Remove the deodorizing filter.
Hold the tab and pull outward.

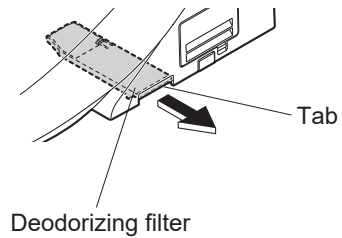

Deodorizing filter

Attention

Do not pull the unit with undue force.
Doing so may cause damage or malfunction.

3. Clean with a tool such as a toothbrush.

When washing with water, dry off all water before reinserting.

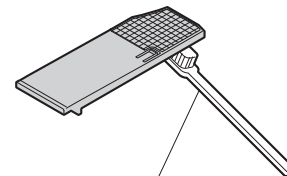

Toothbrush, etc.

4. Reinsert the deodorizing filter.

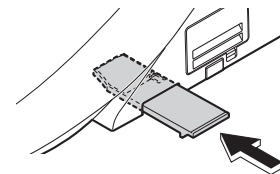

Push firmly until a click sound is heard.

5. Turn the power "ON". (→Page 28)

- ▶ The "Power" LED illuminates.

Drain plug with water supply filter



Approximately once every 6 months
If you think the water pressure has weakened

1. Close the shutoff valve. (→Page 38)
▶ The water supply stops.

⚠ CAUTION

Do not remove the drain plug with water supply filter while the shutoff valve is open.
Otherwise, water may leak out.

2. **Remote control back side**
How to remove the remote control (→Page 14)

Press  to extend the wand,
and then press  again to return the wand.

(Release the pressure from the water supply pipe.)

3. Turn the power "OFF". (→Page 28)

4. Remove the cover and drain plug with water supply filter.

Loosen the drain plug with water supply filter with a flat-head screwdriver and then pull it.

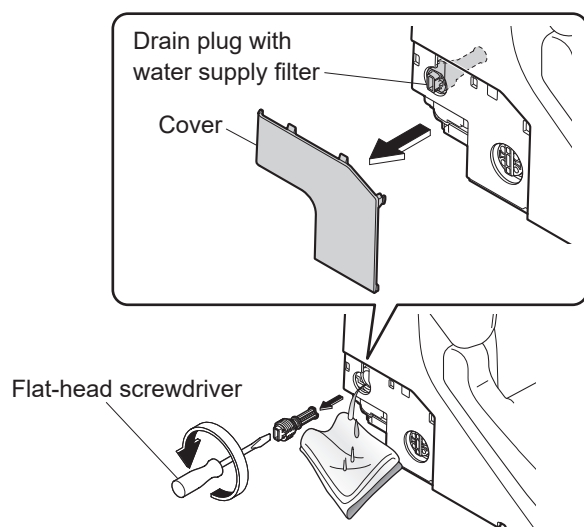

5. Clean the filter with a tool such as a toothbrush.

▶ Also, remove any dust from inside the hole of the drain plug with water supply filter.

6. Reinstall the drain plug with water supply filter and cover.

Insert the drain plug with water supply filter and use a flat-head screwdriver to tighten it securely.

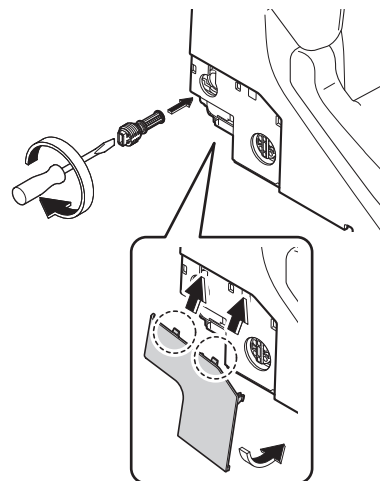

7. Turn the power "ON". (→Page 28)

▶ The "Power" LED illuminates.

8. Open the shutoff valve. (→Page 14)

What to Do?

If the water does not flow due to a water service interruption

Make sure to also check the instruction manual of your bowl unit.

1. Use a bucket to flush the bowl unit.

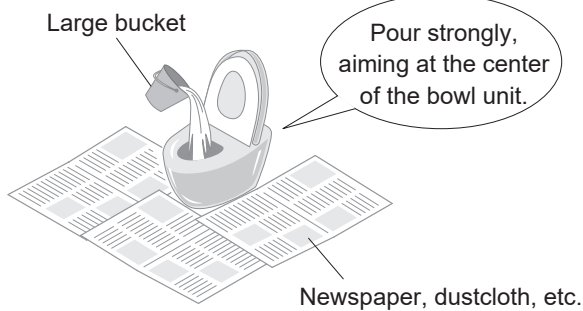

2. If the water level is low after flushing, add more water.
(Until the water level does not rise further.)
▶ Prevents odors.

Attention

When the water supply is restored, make sure to first use water in the bath or kitchen (not with this product) to remove air from the water supply pipes.

Otherwise, air or foreign objects may enter this product, causing failure.

After that, be sure to perform a full flush.

To prevent waste from remaining in the drain pipe.

If you cannot operate with the remote control

If the low battery warning mark "  " on the surface of the remote control is flashing, please replace the batteries.

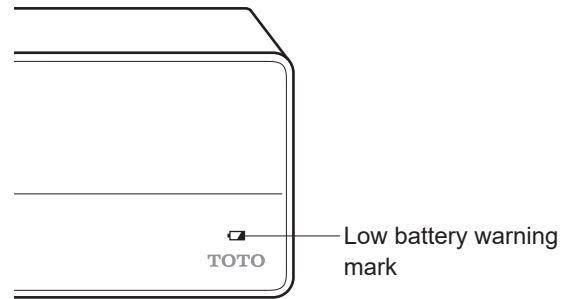

Replacing the batteries

1. Turn the power "OFF". (→Page 28)
2. Remove the remote control from the hanger. (→Page 14)
3. Open the battery cover and replace with two new AAA batteries. (→Page 14)
▶ The low battery warning mark is unilluminated.
4. Mount the remote control in the hanger. (→Page 14)
5. Turn the power "ON". (→Page 28)
▶ The "Power" LED illuminates.

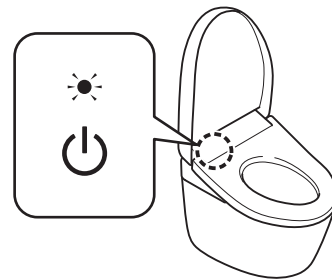

Attention

"ON" and "OFF" settings of the functions such as the energy saver function may be canceled when the batteries are replaced. Set them again.

Freeze Damage Prevention

When the ambient temperature is likely to drop to 32 °F (0 °C) or lower, take measures to prevent freezing.

Attention

When the ambient temperature is likely to drop to 32 °F (0 °C) or lower, do not use the energy saver feature.

May damage the product.

Warm the bathroom or take measures against freezing so that the ambient temperature does not drop below 32 °F (0 °C).



1. Close the shutoff valve. (→Page 38)
 - ▶ The water supply stops.

CAUTION

Do not remove the drain plug with water supply filter while the shutoff valve is open. Otherwise, water may leak out.

2. Drain the water from the toilet tank. Manipulate the lever/button/etc. until the water stops.

3. **Remote control back side**
How to remove the remote control (→Page 14)

Press  to extend the wand,
and then press  again to return the wand.
(Release the pressure from the water supply pipe.)

4. Turn the power "OFF". (→Page 28)

5. Drain the pipe.

- 1) Remove the cover and drain plug with water supply filter.

Loosen the drain plug with water supply filter with a flat-head screwdriver and then pull it.

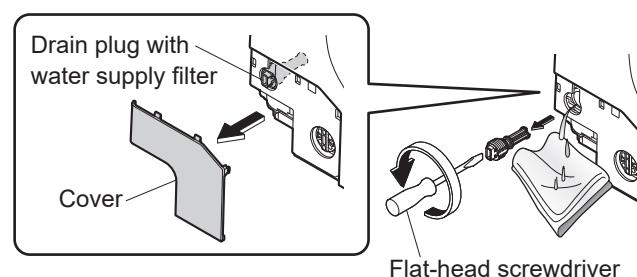

- 2) Drain the water from the water supply hose.

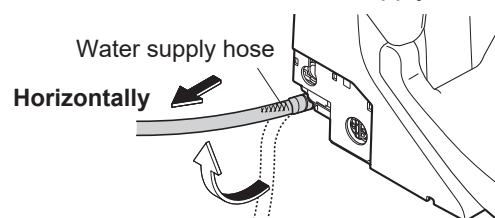

- 3) When water draining is completed, reinstall the drain plug with water supply filter and cover. Insert the drain plug with water supply filter and use a flat-head screwdriver to tighten it securely.

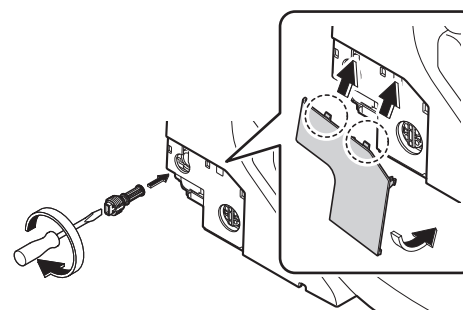

6. Turn the power "ON". (→Page 28)

▶ The "Power" LED illuminates.

7. Set the water and toilet seat temperature to "High". (→Page 18)

▶ To maintain the temperature, close the toilet seat and toilet lid after finishing work.

To use the product again

▶ The water needs to be resupplied. (→Page 37)

What to Do?

Long Periods of Disuse

If the toilet is in a location you will not visit for a long time, drain the water.

The water in the tank may cause malfunctions or become contaminated and cause skin irritation or other problems.

(The water may freeze, causing damage to the product.)

Attention

When there is a risk of freezing, take measures to prevent freezing. (→Page 35)
Otherwise, the product may break down.

How to drain the water



1. Close the shutoff valve. (→Page 38)
▶ The water supply stops.

CAUTION

Do not remove the drain plug with water supply filter while the shutoff valve is open.
Otherwise, water may leak out.

2. Drain the water from the toilet tank.
Manipulate the lever/button/etc. until the water stops.

3. **Remote control back side**
How to remove the remote control (→Page 14)

Press  to extend the wand,
and then press  again to return the wand.

(Release the pressure from the water supply pipe.)

4. Turn the power "OFF". (→Page 28)

5. Drain the pipe.

- 1) Remove the cover and drain plug with water supply filter.

Loosen the drain plug with water supply filter with a flat-head screwdriver and then pull it.

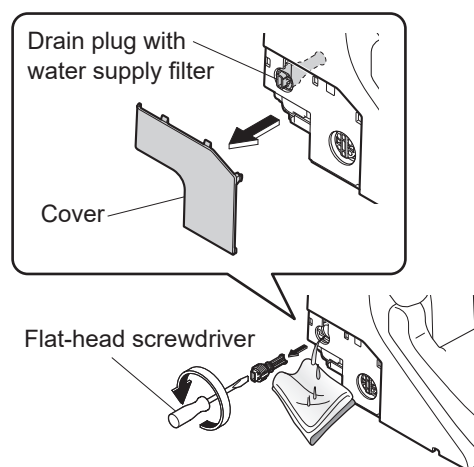

- 2) Drain the water from the water supply hose.

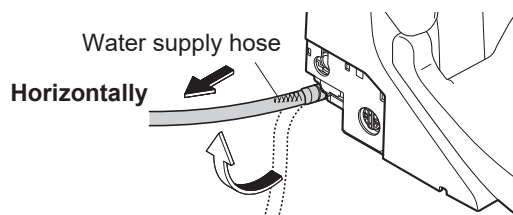

- 3) When water draining is completed, reinstall the drain plug with water supply filter and cover. Insert the drain plug with water supply filter and use a flat-head screwdriver to tighten it securely.

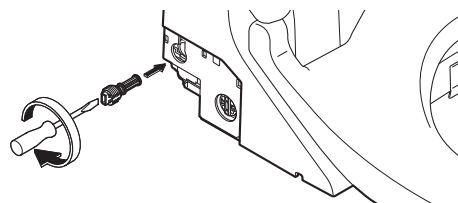

- 6.** Loosen the water drain plug until water comes out from around the wand.

Water comes out from around the wand.
(It takes about 3 minutes to complete draining.)

*The water drain plug cannot be removed.

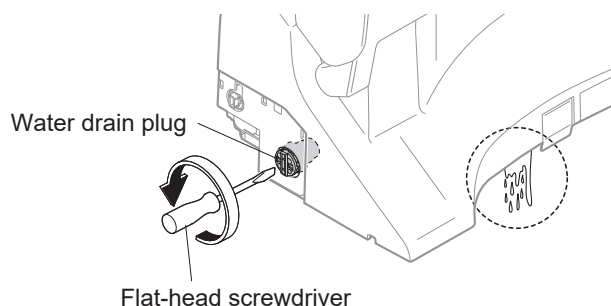

- 7.** Tighten the water drain plug securely with a flat-head screwdriver and reinstall the cover.

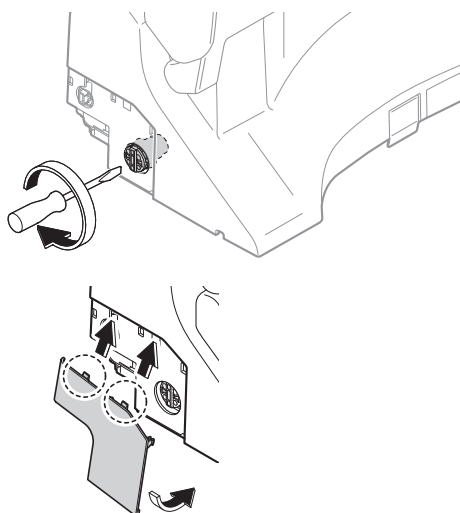



If water may get frozen

- ▶ Add antifreeze solution to the water in the bowl to prevent freezing.
(The antifreeze solution should not be flushed out. Collect it before using the toilet and dispose of it.)

To use the product again

- ▶ The water needs to be resupplied. (→see the right column)

Resupplying the Water

- 1.** Open the shutoff valve. (→Page 14)
 - ▶ Check that water is not leaking from a pipe or the main unit.
- 2.** If the power is not on, turn the power ON. (→Page 28)
 - ▶ The "Power" LED illuminates.
- 3.** Discharge water from the wand.
 - 1) Pressing down the right side of the toilet seat,
 - 2)  Press "Rear washing" button on the remote control to discharge water from the wand for about 2 minutes.
It takes about 1 minute maximum before water comes out.
▶ Catch the water in a paper cup or other receptacle.
 - 3)  Press the "Stop" button on the remote control.

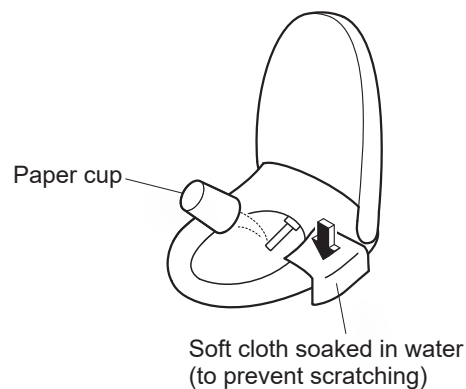

If the remaining water has frozen and no water comes out

- ▶ Heat the inside of the bathroom, and warm the water supply hose and shutoff valve using a cloth soaked in warm water.

Troubleshooting

First, try the actions described on pages 38–41. If the problem persists, consult the installer, seller or TOTO customer service (→see *contact information on the back cover*).

⚠ CAUTION

If a water leak occurs, close the shutoff valve.

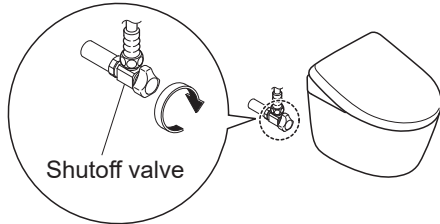

Please check first (A–C)

A: Is the Power LED illuminated?
Is the main unit working?

Is the breaker on the distribution board turned on?

- ▶ Check whether there is a power outage or the breaker has turned "OFF".

Is the "Power ON/OFF" setting "OFF"?

- ▶ Switch it to "ON" with the remote control. (→Page 14 step 2-2.2)

Is the "Power" LED on the main display flashing?

- ▶ The main unit is not mounted properly. Mount them correctly again. (→Page 30)

B: Is the Energy saver LED lit?

- ▶ While the LED is lit, energy saver (→Pages 22, 23) is in operation, so the toilet seat temperature may be reduced or the heater may be turned off.

C: Is the remote control working?

Is the low battery warning mark  on the surface of the remote control flashing?

- ▶ Replace the batteries. (→Pages 14, 34)

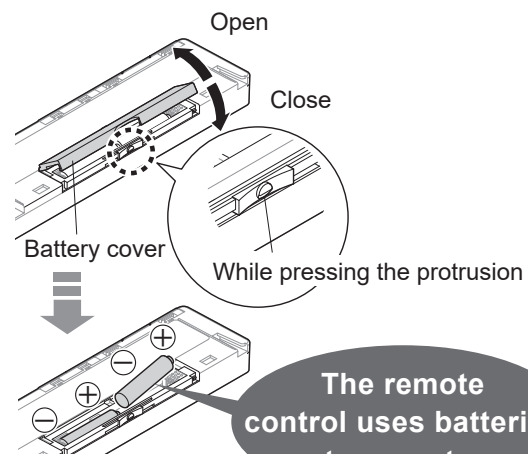

Is the remote control transmitter or the remote control receiver blocked?

- ▶ Remove obstructions, dirt, water droplets or any other blockages.

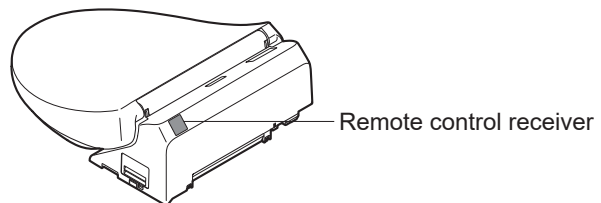
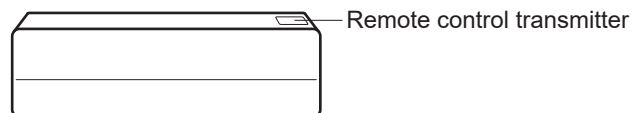

Rear Washing, Front Washing and Wand

Trouble	Please check
The wand (or washing water) does not come out	<p>Has the toilet been sat "ON" and used continuously for 2 hours or longer? (If so, operation is stopped for safety purposes.)</p> <p>▶ Stand up from the seat and then use again.</p> <hr/> <p>The seat switch will not turn on unless you sit on the seat properly.</p> <p>▶ Sit back on the toilet seat. (→Page 9)</p> <hr/> <p>Are you using a toilet seat cover, a toilet lid cover or a seat for infants?</p> <p>▶ Remove any covers. When using a seat for infants or a soft highchair, remove after each use. (→Page 10)</p>
The wand extends but the washing water does not come out / The washing water pressure is weak	<p>Has a water failure occurred?</p> <p>▶ ■ Press "Stop" button on the remote control and wait until water service is restored.</p> <hr/> <p>Is the shutoff valve closed?</p> <p>▶ Fully open the shutoff valve. (→Page 14)</p> <hr/> <p>Is the drain plug with water supply filter clogged with foreign matter?</p> <p>▶ Clean the filter. (→Page 33)</p> <hr/> <p>Is the water pressure set to a low level? (→Page 16)</p> <hr/> <p>Is the water drain plug loosened?</p> <p>▶ Tighten the water drain plug securely. (→Page 37)</p>
The washing water is cold	<p>Is the warm water temperature set to "OFF" or a low level? (→Pages 18, 19)</p> <hr/> <p>When the temperature of the water supply or the bathroom is low, the water temperature may be low when first sprayed.</p> <hr/> <p>Is the timer energy saver in operation?</p> <p>▶ The energy saver feature is on when the "Energy saver" LED is on and the "Power" LED is off on the main display.</p> <p>When you sit on the seat, the warm water heater is temporarily turned on and water is warmed in about 10 minutes. (→Pages 22, 23)</p> <p>▶ When the timer energy saver is set to "ON", you can also turn it "OFF". (→Page 24)</p>
Stops in the middle of use	<p>"Rear washing" and "Front washing" stop automatically after about 5 minutes of continuous use.</p> <hr/> <p>Does the seat switch have difficulty detecting?</p> <p>▶ Sit back on the toilet seat. If you get up slightly from the seat, or sit forward on the seat, the seating switch may temporarily stop detecting your presence. (→Page 9)</p>
Water comes out unexpectedly from the wand	<p>Water may sometimes come out from around the wand when it expands in the warm water tank.</p>



Troubleshooting

Warm air drying

Trouble	Please check
The dryer temperature is low	Is the dryer temperature set to low level? (<i>→Page 18</i>)
Stops in the middle of use	<p>The feature stops automatically after about 10 minutes of continuous use.</p> <p>Does the seat switch have difficulty detecting?</p> <p>▶ Sit back on the toilet seat. If you get up slightly from the seat, or sit forward on the seat, the seating switch may temporarily stop detecting your presence. (<i>→Page 9</i>)</p>

Toilet Seat and Toilet Lid

Trouble	Please check
The toilet seat is cold	<p>Is the toilet seat temperature set to "OFF" or a low level? (<i>→Pages 18, 19</i>)</p> <p>Is energy saver in operation?</p> <p>The energy saver feature is on when the "Energy saver" LED is on and the "Power" LED is off on the main display. When you sit on the seat, the toilet seat heater is turned on temporarily and the seat is warmed in about 15 minutes. (<i>→Pages 22, 23</i>)</p> <p>▶ You can turn it "OFF" if the energy saver feature is "ON". (<i>→Page 24</i>)</p> <p>Have you been seated for a long time?</p> <p>After about 20 minutes of sitting, the temperature starts going down, and after about 1 hour, the toilet seat heater is turned "OFF".</p> <p>▶ Stand up from the seat and then use again.</p> <p>Did you put anything on the toilet seat or the toilet lid?</p> <p>▶ Remove anything placed on top of the toilet seat or lid.</p> <p>Is a toilet lid or seat cover installed?</p> <p>▶ Remove any covers. (<i>→Page 10</i>)</p>

Energy Saver

Trouble	Please check
The Energy saver LED does not light up	<p>Has the power to the product been turned "OFF" or was there a power outage?</p> <p>The Energy saver LED on the main display may go off when the power is turned ON even if the energy saver feature is ON.</p> <p>It will turn on within about 24 hours since the setting is retained.</p>
The timer energy saver feature is not working	<p>Have the batteries in the remote control been replaced?</p> <p>"Timer energy saver" may be canceled when the batteries are replaced.</p> <p>▶ Set the timer energy saver again at the time you want to start it. (<i>→Page 24</i>)</p>
The auto energy saver feature is not working	<p>Because this function takes several days learning the usage conditions before starting energy saver, the amount of energy saving may be low, depending on the frequency of use.</p> <p>▶ Check the energy saver setting. (<i>→Pages 22, 23</i>)</p>

Deodorizer

Trouble	Please check
The deodorizer seems to be not working	<p>Is "Deodorizer" set to "OFF"?</p> <p>▶ Set to "ON". (→Page 25)</p> <hr/> <p>Even after sitting down, you do not hear operation sounds.</p> <p>▶ Sit back on the toilet seat.</p> <p>If you hear an operation sound from the deodorizer, but odors are not removed.</p> <p>▶ Clean the deodorizing filter. (→Page 32)</p>
A strange odor is emitted	<p>Are you using an air freshener or deodorizer that you purchased separately?</p> <p>Doing so may reduce the effectiveness of the product's deodorizer or cause strange odors.</p> <p>▶ Remove the air freshener or deodorizer.</p>

Others

Trouble	Please check
Water is leaking from the plumbing connections	<p>If the nut of the connecting pipe is loosened, retighten it by hand. Do not use any tool.</p> <p>▶ If the water leak does not stop, close the shutoff valve and consult with TOTO customer service. (→see contact information on the back cover)</p>
The main unit is unstable	<p>There is clearance between the toilet seat cushion and the bowl unit for activating the seat switch.</p> <p>▶ When you sit on the toilet seat, the toilet seat subsides slightly to activate the seat switch. (→Page 9)</p> <hr/> <p>Are the bolts that anchor the main unit loose?</p> <p>▶ Remove the main unit and then firmly tighten the base plate bolts.</p>
The main unit makes a sound	<p>When sitting on the toilet seat</p> <p>When "Pre-mist" is "ON", you hear operation sounds for preparing the pre-mist or spraying mist in the bowl unit.</p> <p>▶ You can turn it "OFF". (→Page 25)</p>
You feel air in the bowl unit when sitting on the toilet seat	<p>A mist is sprayed inside the bowl unit to make it more difficult for dirt to adhere when sitting on the toilet seat. You may feel air when a mist is sprayed.</p> <p>▶ You can turn it "OFF". (→Page 25)</p>
The main unit cannot be operated through the remote control	<p>Follow the instructions "Please check first (A–C)". (→Page 38)</p> <hr/> <p>The following conditions may affect the reception performance of the remote control, resulting in not being able to operate the main unit.</p> <ul style="list-style-type: none"> • When the room size, the layout of fixtures etc. interferes • When the color of the ceiling or walls is too dark, or their shape or material interferes • When there is a rack or cabinet installed on the wall behind the main unit • When an inverter lighting system is used <p>▶ Change the position of the remote control and try again.</p>

Specifications

Item	T1SW2491
Rated power supply	AC 120 V, 60 Hz
Rated power consumption	404 W
Maximum power consumption ^{*1}	514 W
Type of water heater	Tank type
Power cord length	3.9 ft (1.2 m)
Water protection level	IPX4
Washing	
Spray volume ^{*2}	Rear washing: Approx. 0.07 - 0.11 gal/min (Approx. 0.27 - 0.43 L/min) Front washing: Approx. 0.08 - 0.11 gal/min (Approx. 0.29 - 0.43 L/min)
Water temperature	Adjustable temperature range: OFF, about 95-104 °F (about 35-40 °C)
Toilet tank capacity	Approx. 0.13 gal (Approx. 0.49 L)
Heater capacity	225 W
Safety device	Temperature fuse, anti-idling float switch
Backflow prevention device	Vacuum breaker, Check valve
Heated seat	
Surface temperature	Adjustable temperature range: OFF, about 82 - 97 °F (about 28 - 36 °C) <Auto energy saver: about 79 °F (about 26 °C)>
Heater capacity	50 W
Safety device	Temperature fuse
Deodorizer	
Method	O ₂ deodorization
Airflow volume	Normal mode: Approx. 3.18 ft ³ /min (Approx. 0.09 m ³ /min)
Power consumption	Normal mode: Approx. 1.7 W
Warm air dryer	
Warm air temperature ^{*3}	Adjustable temperature range: about 95 - 140 °F (about 35 - 60 °C)
Airflow volume	Approx. 8.83 ft ³ /min (Approx. 0.25 m ³ /min)
Heater capacity	347 W
Safety device	Temperature fuse
Water supply pressure	Minimum required water pressure: 7.25 PSI (0.05 MPa) <Dynamic>, Maximum water pressure: 108.78 PSI (0.75 MPa) <Static>
Water supply temperature	32 - 95 °F (0 - 35 °C)
Working ambient temperature	32 - 104 °F (0 - 40 °C)
Dimensions	W 1.27 x D 1.74 x H 0.55 ft (W 387 x D 531 x H 168 mm)
Weight	About 11 lb (about 5 kg)

When disposing of this product, please follow your local or state guidelines for proper disposal.

*1 Maximum power consumption for warm water or heated toilet seat.

*2 At 29 PSI (0.20 MPa) water pressure

*3 Temperature around the warm air outlet measured by TOTO.

Limited Warranty

One Year Limited Warranty

1. TOTO warrants its product to be free from defects in materials and workmanship during normal use when properly installed and serviced, for a period of one (1) year from date of purchase. This limited warranty is extended only to the ORIGINAL PURCHASER of the Product and is not transferable to any third party, including but not limited to any subsequent purchaser or owner of the Product. This warranty applies only to TOTO Product is purchased and installed in USA and Canada.
2. TOTO's obligations under this warranty are limited to repair, replacement or other appropriate adjustment, at TOTO's option, of the Product or parts found to be defective in normal use, provided that such Product was properly installed, used and serviced in accordance with instructions.
TOTO reserves the right to make such inspections as may be necessary in order to determine the cause of the defect. TOTO will not charge for labor or parts in connection with warranty repairs or replacements. TOTO is not responsible for the cost of removal, return and/or reinstallation of the Product.
3. This warranty does not apply to the following items:
 - a) Damage or loss sustained in a natural calamity such as fire, earthquake, flood, thunder, electrical storm, etc.
 - b) Damage or loss resulting from any accident, unreasonable use, misuse, abuse, negligence, improper care, or maintenance of the Product.
 - c) Damage or loss resulting from sediments or foreign matter contained in a water system.
 - d) Damage or loss resulting from the quality of water in the region where the product is used.
 - e) Damage or loss resulting from improper installation or from installation of the Product in a harsh and/or hazardous environment, or improper removal, repair or modification of the Product. This includes locations where the water pressure is above local codes or standards. (NOTE : Product model codes allow a maximum of 80 PSI. Check local codes or standards for requirements).
 - f) Damage or loss resulting from electrical surges or lightning strikes or other acts which are not the fault of TOTO or which the Product is not specified to tolerate, including failure to use the factory equipped cord and plug or use of a loose or faulty electrical outlet or use of a current or socket other than a 120 V, 60 Hz electrical current from a GFI (ground, fused) socket.
 - g) Damage or loss resulting from normal and customary wear and tear, such as gloss reduction, scratching or fading over time due to use, cleaning practices or water or atmospheric conditions, including but not limited to, the use of bleach, alkali, acid cleaners, dry (powder) cleaners or any other abrasive cleaners or the use of metal or nylon scrubbers.
4. If the Danger Label which has been placed over the seams on the back of the Products main unit is broken or otherwise not intact, this limited warranty is void.
5. In order for this limited warranty to be valid, proof of purchase is required. TOTO encourages warranty registration upon purchase to create a record of Product ownership at <http://www.totousa.com>. Product registration is completely voluntary and failure to register will not diminish your limited warranty rights.
6. If the Product is used commercially or is installed outside of USA or Canada. TOTO warrants the Product to be free from defects in materials and workmanship during normal use for one (1) year from the date of installation of the Product, and all other terms of this warranty shall be applicable except the duration of the warranty.
7. This warranty gives you specific legal rights. You may have other rights which vary from state to state, province to province or country to country.
8. To obtain warranty repair service under this warranty, you must take the Product or deliver it prepaid to a TOTO service facility together with proof of purchase (original sales receipt) and a letter stating the problem, or contact a TOTO distributor or products service contractor, or write directly to TOTO U.S.A., INC., 1155 Southern Road, Morrow, GA 30260 (888) 295 - 8134 or (678) 466-1300, if outside the U.S.A. If, because of the size of the Product or nature of the defect, the Product cannot be returned to TOTO, receipt by TOTO of written notice of the defect together with proof of purchase (original sales receipt) shall constitute delivery. In such case, TOTO may choose to repair the Product at the purchase'r s location or pay to transport the Product to a service facility.

WARNING! TOTO shall not be responsible or liable for any failure of, or damage to, this Product caused by either chloramines in the treatment of public water supply or cleaners containing chlorine (calcium hypochlorite).
NOTE: The use of a high concentrate chlorine or chlorine related product's can seriously damage the fittings. This damage can cause leakage and serious property damage.

THIS WRITTEN WARRANTY IS THE ONLY WARRANTY MADE BY TOTO. REPAIR, REPLACEMENT OR OTHER APPROPRIATE ADJUSTMENT AS PROVIDED UNDER THIS WARRANTY SHALL BE THE EXCLUSIVE REMEDY AVAILABLE TO THE ORIGINAL PURCHASER. TOTO SHALL NOT BE RESPONSIBLE FOR LOSS OF THE PRODUCT OR FOR OTHER INCIDENTAL, SPECIAL OR CONSEQUENTIAL DAMAGES OR EXPENSES INCURRED BY THE ORIGINAL PURCHASER, OR FOR LABOR OR OTHER COSTS DUE TO INSTALLATION OR REMOVAL, OR COSTS OF REPAIRS BY OTHERS, OR FOR ANY OTHER EXPENSE NOT SPECIFICALLY STATED ABOVE. IN NO EVENT WILL TOTO'S RESPONSIBILITY EXCEED THE PURCHASE PRICE OF THE PRODUCT. EXCEPT TO THE EXTENT PROHIBITED BY APPLICABLE LAW, ANY IMPLIED WARRANTIES, INCLUDING THAT OF MERCHANTABILITY OR FITNESS FOR USE OR FOR A PARTICULAR PURPOSE, ARE EXPRESSLY DISCLAIMED. SOME STATES DO NOT ALLOW LIMITATIONS ON HOW LONG AN IMPLIED WARRANTY LASTS, OR THE EXCLUSION OR LIMITATION OF INCIDENTAL OR CONSEQUENTIAL DAMAGES, SO THE ABOVE LIMITATION AND EXCLUSION MAY NOT APPLY TO YOU.

TOTO

TOTO U.S.A., Inc. 1155 Southern Road Morrow, GA 30260
Phone : (770) 282-8686

Warranty Registration and Inquiry

For product warranty registration, TOTO U.S.A. Inc. recommends On-Line Warranty Registration. Please visit our web site <http://www.totousa.com>. If you have questions regarding warranty policy or coverage, please contact TOTO U.S.A. Inc.,

Customer Service Department, 1155 Southern Road, Morrow, GA 30260 (888) 295 - 8134 or (678) 466 - 1300 when calling from outside of U.S.A.

- You are advised to record the following information to allow quick service.

Date of purchase :	Name of shop :
Date : year month day	Tel : ()



This code is for manufacturer management use.

2024.7.10
D07K51